

Design and Implementation of PLC-Based Autonomous Construction System of Unmanned Vibratory Roller

Weizu Huang¹, Dong Wang^{1,*}, Zuodong Xiao¹, Qiang Yao² and Danjie Du³

Abstract: The vibratory roller is a piece of vital construction machinery in the field of road construction. The unmanned vibratory roller efficiently utilizes the automated driving technology in the vehicle engineering field, which is innovative for the unmanned road construction. This paper develops and implements the autonomous construction system for the unmanned vibratory roller. Not only does the roller have the function of remote-controlled driving, but it also has the capability of autonomous road construction. The overall system design uses the Programmable Logic Controller (PLC) as the kernel controller. It establishes the communication network through multiple Input/Output (I/O) modules, Recommended Standard 232 (RS232) serial port, Controller Area Network (CAN) bus, and wireless networks to control the roller vehicle completely. The locating information is obtained through the Global Navigation Satellite System (GNSS) satellite navigation equipment group to support the process of autonomous construction. According to the experimental results, the autonomous construction system can finally enable the roller to perform driving operations and construction independently, which was a significant step forward in engineering application.

Keywords: PLC-based, autonomous construction, unmanned system, vibratory roller, road engineering.

1 Introduction

Compared with ordinary cars, the research and application of automated driving technology on construction machinery vehicles is still in its infancy. Construction machinery vehicles serve engineering construction, so they have a variety of different requirements from ordinary cars. The difference lies in the fact that these vehicles not only need to be able to drive automated like human drivers but also need to be able to complete a series of construction processes at the construction site like construction workers [Chayama, Fujioka, Kawashima et al. (2014)]. These two parts are indispensable and together constitute a completely autonomous construction system.

¹ School of Instrument Science and Engineering, Southeast University, Nanjing, 210096, China.

² Anhui Jianghuai Automobile Group Corp. Ltd., Hefei, 230022, China.

³ North Carolina State University, Raleigh, USA.

* Corresponding Author: Dong Wang. Email: kingeast16@seu.edu.cn.

Received: 16 January 2020; Accepted: 27 April 2020.

Generally, construction machinery vehicles work on the harsh construction site for a long time, not to mention the long engineering project period and high operational repeatability. However, replacing the construction workers (also known as constructors) with an unmanned system can solve these problems, and the unmanned construction vehicle needs to consider both automated driving and autonomous construction [Anderson, Karumanchi and Iagnemma (2012); Werfel, Petersen and Nagpal (2014); Ali and Bagchi (2018)]. In particular, the construction process is process-oriented in most cases, which is suitable for implementation by machine automation.

As a vital construction machinery in the road engineering field, vibratory roller uses its gravity and mechanical vibration to effectively compact road construction materials, which has been widely used in numerous large projects such as highways, expressways, railways, and airport runways [Werfel, Petersen and Nagpal (2014); Vahedifard, Nili and Meehan (2010)]. Even so, the road construction also has the general shortcomings of engineering construction: long construction duration, high operational repeatability, and poor working environment. For example, the vibratory roller usually has energetic vibration and high noise during construction, and the constructor must always be in the roller during the whole operating process. As a result, it is no doubt that this situation will cause harm to the health of the constructor [Yao, Feng, Zhu et al. (2007); Zhang, Feng and Liu (2007); Kitahara and Takashi (2016)], so the vibratory roller is not suitable for humans to operate.

Therefore, the design and implementation of the unmanned vibratory roller is of considerable significance, which effectively saves labor and engineering construction costs. Furthermore, it gets rid of the limitations that vehicles can only be driven by human drivers, which is typically beneficial to improve the automation level and safety of engineering construction.

2 System overview

2.1 Demand analysis

For the unmanned vibratory roller, one of the ultimate goals of its design is to replace the human driver; hence it must first be remotely managed and controlled by the constructor [Chayama, Fujioka, Kawashima et al. (2014)]; secondly, it needs to have the same level of proficient behavior as the general constructor. Notably, when a constructor operates the vibratory roller, the vehicle is entirely controlled by the control panel in the cockpit of the roller.

Therefore, for design requirements, the unmanned vibratory roller first needs to take over the control panel completely, and then demands a similar remote control scheme to support the operations. Through these, the constructor can drive the vibratory roller to the construction site and then start the process of autonomous construction. Besides, the compaction of the roller has a fixed procedure: during the construction, the roller repeatedly compacts a construction area along the zigzag route parallel to the road [Kayacan, Saeys, Ramon et al. (2018)]. Consequently, the autonomous construction system of the unmanned vibratory roller adopts a path planning and tracing scheme. In this way, the roller requires a sensor device to obtain locating information about itself and its surroundings, such as the Global Navigation Satellite System (GNSS) [Suzuki, Kitamura, Amano et al. (2011); Fu,

Jenelius and Koutsopoulos (2017)]. Following this, at the software level, the path planning scheme can be performed through the construction area and the locating information [Kuenzel, Teizer, Mueller et al. (2016); Tan, Zhao, Yang et al. (2017); Yao, Xie, Qiang et al. (2018)]. Finally, the unmanned vibratory roller can complete the construction of an area by tracing these paths with the corresponding construction technology.

2.2 System design

According to the previous analysis, the design requirements of the autonomous construction system are as follows:

Firstly, the lower computer should take over all the driving and construction functions provided by the vibratory roller.

Secondly, through wireless communication, the upper computer can remotely control the lower computer, thereby controlling the vibratory roller.

Thirdly, the unmanned vibratory roller can independently complete the compaction works in an area based on the construction technology under the control of the constructor.

Under these design conditions, the overall block diagram of the system is shown in Fig. 1. The lower computer positioned in the cockpit of the vibratory roller takes over all the electric control signals. Meanwhile, it can receive the locating information provided by sensors through the wired connection and can communicate with the upper computer in the half-duplex mode wirelessly.

At the same time, the upper computer has the Human-Machine Interface (HMI), whose interface is similar to the control panel and can be operated by the constructor easily so that it will send commands wirelessly to the lower computer in real-time.

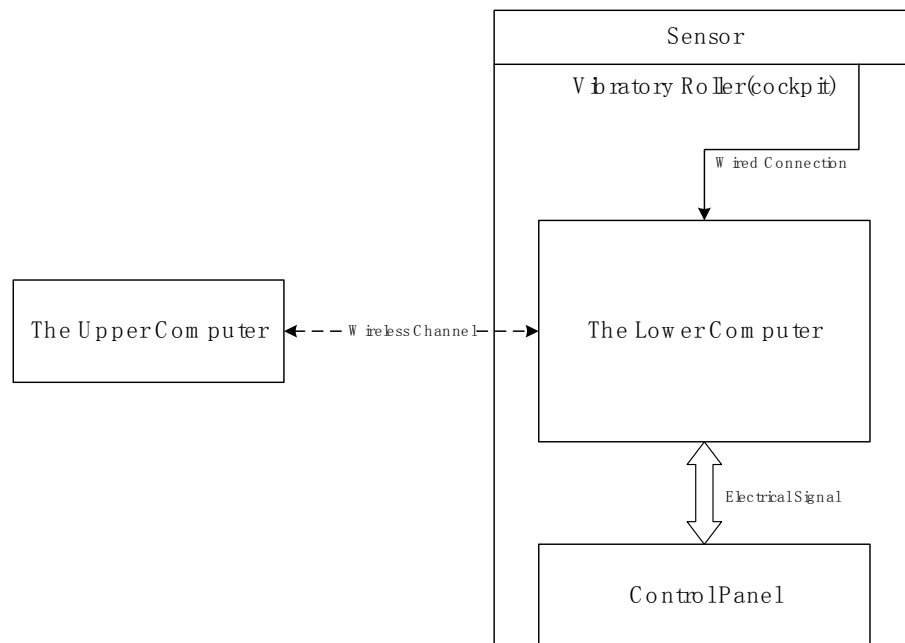

Figure 1: The overall block diagram of the system

3 Implementation

3.1 Hardware design

According to the system design, the autonomous construction system of the unmanned vibratory roller can be divided into three main parts: the control, the execution, and the remote control [Schmidt-Didlaukies, Sørensen and Pettersen (2018); Zhu and Yang (2019)], as shown in Fig. 2.

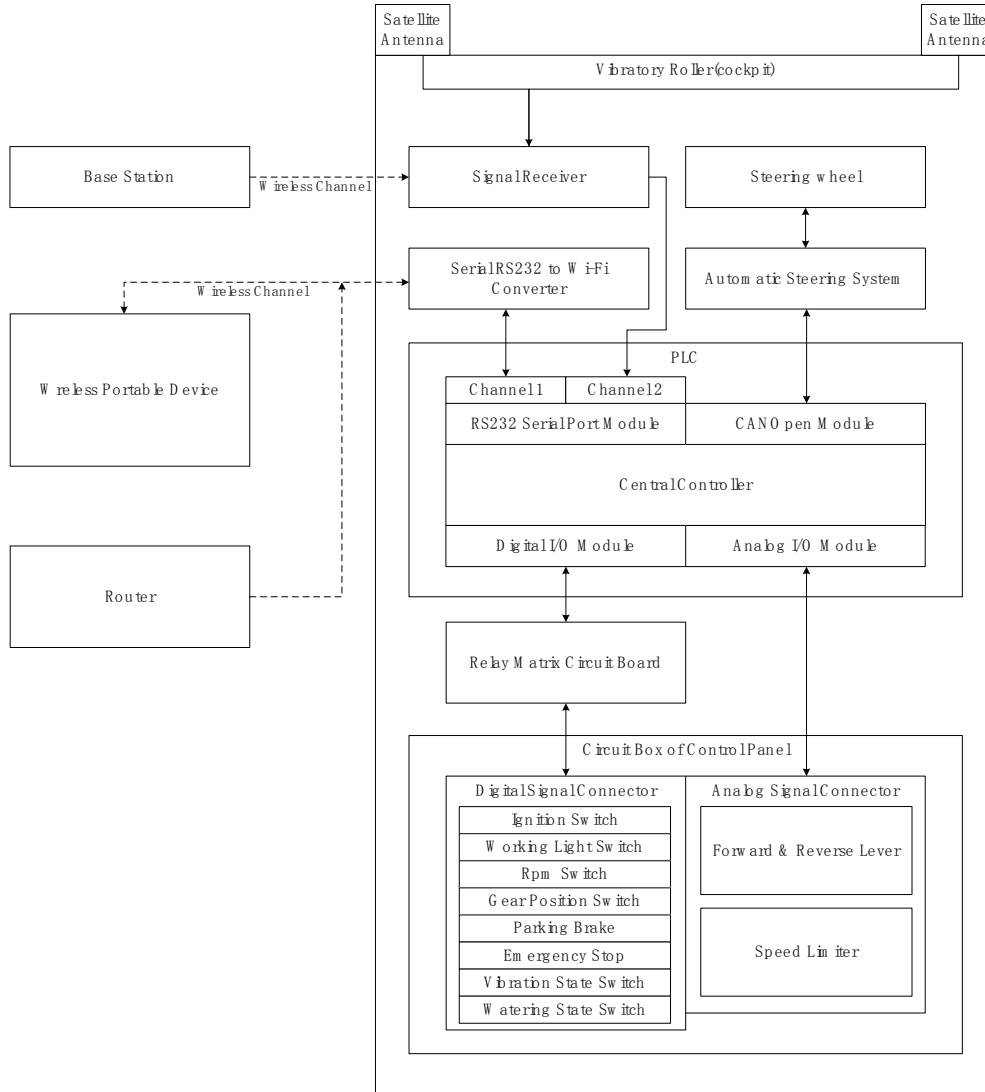

Figure 2: The hardware design of the unmanned vibratory roller

Among them, the control part uses the Programmable Logic Controller (PLC) as the control system of its lower computer. The PLC contains its central controller and I/O modules. Besides, the GNSS equipment group also belongs to the control part for obtaining locating

information, which connects to the I/O module through the RS232 standard serial port. Accordingly, the executive part refers to the control panel and steering wheel in the cockpit of the vibratory roller, which directly controls all driving and construction functions of the roller. Specifically, the operation on the control panel will be input to the circuit box as an electrical signal. Thus, the PLC takes the place of the control panel and output an electrical signal, and sends it to the circuit box through the I/O module (wherein the digital signal generates a stable output through the relay matrix circuit board) so that the PLC can achieve complete control of the roller. As for the steering wheel, the I/O module can control the steering wheel via the CAN bus by installing an automatic steering system on the steering wheel. At last, the remote control part consists of the wireless environment configuration devices and a portable device at the construction site.

Through the interconnection of these devices and equipment, it has formed the transmission of the remote control signal from the upper computer (wireless portable device) to the lower computer (PLC) and the transmission of the control signal from the lower computer (PLC) to the vibratory roller driving system (control panel).

Further, the control panel in the cockpit of the vibratory roller has the following operation functions: steering wheel, ignition switch, working light switch, rpm switch, gear position switch, parking brake, emergency stop, vibration state switch, watering state switch, forward and reverse lever and speed limiter. The structure and detailed description of the control panel is shown in Fig. 3, which includes all the driving and construction functions of the vibratory roller.

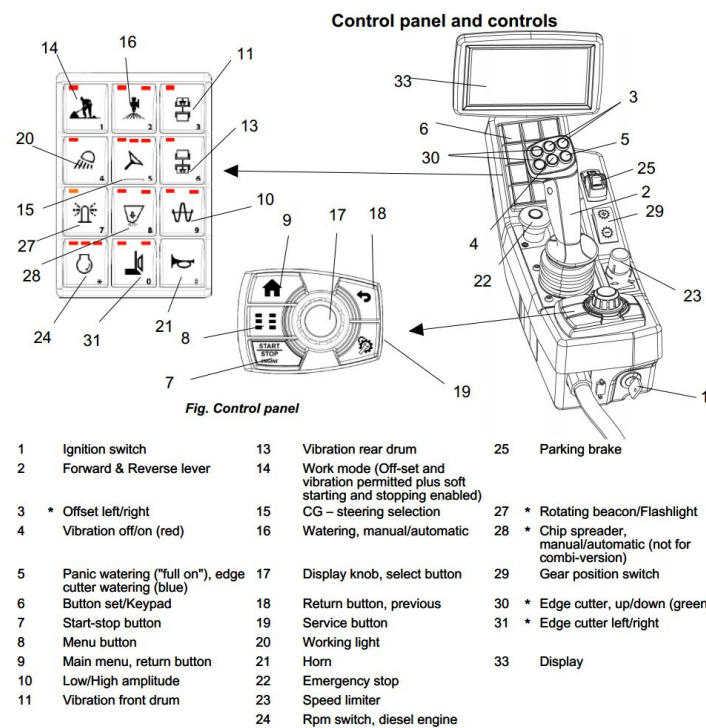

Figure 3: The structure and detailed description of the control panel



Figure 4: The automatic steering system

The steering wheel is taken over by the automatic steering system shown in Fig. 4. The system consists of four sets of components: an electric servo, a steering controller, a two-wire harness and a connector device. The first two are the actuator and controller of the steering wheel, and the latter two are responsible for the electrical connection. The electric servo is mounted on the original steering wheelbase, replacing the original steering wheel of the roller and connected to the steering controller through a two-wire harness and a connector. The steering controller is a black box with a metal case, as shown in Fig. 5. It has four connectors on the side, and a black circle in this figure marks the power connector. The remaining functions in the circuit box under the control panel are through the input and output signals of the circuit. The automatic steering system is mounted on the original steering wheel and controlled via the CAN bus according to the communication protocol.

The central controller used by the lower computer PLC uses the German Beckhoff PLC device group, as shown in Fig. 6, including the central controller (a), EtherCAT digital/analog I/O module (b), RS232 dual-channel serial port module (c), CANOpen module (d).

Since the circuit box under the control panel of the roller includes digital and analog signals, which requires I/O modules for digital and analog signals. The wireless signal transmission and reception in one of its channels by RS232 serial port module and the automatic steering system is communicating by the CANOpen module.



Figure 5: The steering controller



(a)

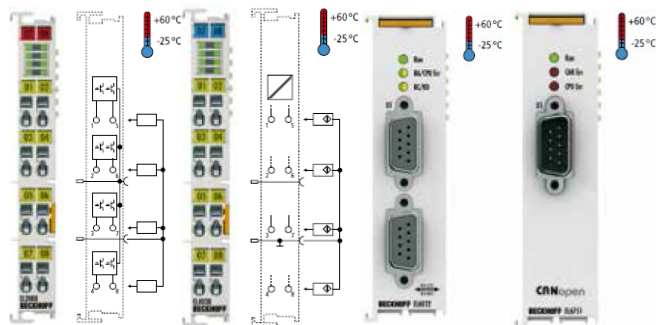

(b)

(c)

(d)

(e)

Figure 6: Beckhoff PLC device group

Therefore, the central controller transmits digital and analog signals from the I/O, and the CANOpen device transmits the CAN bus signals. The digital signal output by the I/O connect to the relay matrix circuit board, and the digital signal with a stable voltage is output from the relay matrix board. The relay matrix circuit board shown in Fig. 7 is connected to various signal controllers in the cockpit control panel of the vibratory roller. At the same time, the analog signal output from the I/O is connected to the forward & reverse lever and speed limiter in the control panel, and the CAN bus signal output from the CANOpen device is connected to the automatic steering system.

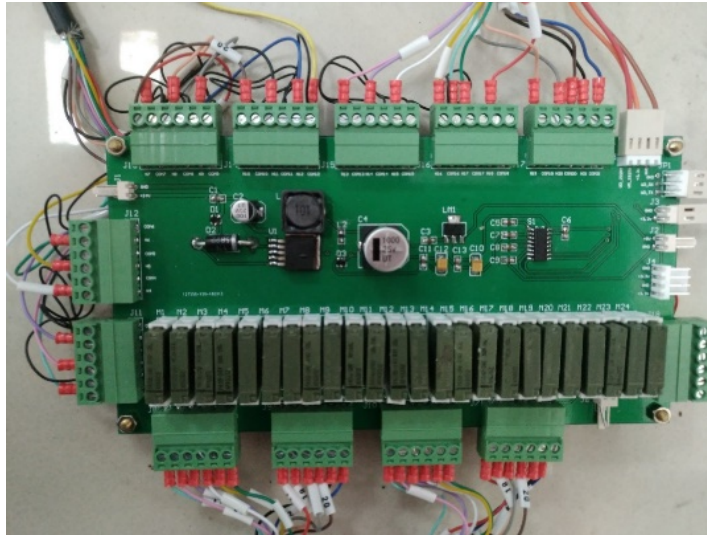

Figure 7: The relay matrix circuit board

In terms of sensor locating, the GNSS equipment group takes charge of acquiring locating information. The equipment group includes a satellite signal receiver, satellite antennas, and the base station. The signal receiver receives the phase signal provided by the satellite and the base station and obtains high-precision locating by the operation of the Real-Time Kinematic (RTK) technique. After that, the satellite locating data transmits to the PLC central controller through the RS232 serial port module.

In the remote control part, a router is in charge of configuring the on-site Wi-Fi wireless environment, and an Android-based tablet computer for the wireless portable device, which is the upper computer. The serial RS232 to Wi-Fi server converter(wireless transceiver device) converts the data format of the wireless information. It connects to the PLC through the RS232 serial port module, establishes communication between the PLC and tablet computer, and the wireless signal can transmit in both directions.

3.2 Software design

At the software level, it is necessary to develop the control part and the remote control part of the autonomous control, and finally, the execution part can perform the required operations. Fig. 8 shows the block diagram of the software layer control.

First, in the remote control part, the Android application in the tablet contains two

functions: remote control and autonomous construction. The remote control function refers to the operation of the control interface of the tablet computer by the constructor, and the corresponding control command is sent to the PLC remotely to operate. The autonomous construction includes the functions of operation mode setting, construction state control, and construction data recording. Notably, the autonomous construction means that the PLC performs closed-loop control based on the locating information and the steering angle of the feedback, and autonomously follows the planned construction path, and adopts the vibration and watering operation to complete the road construction according to the corresponding construction technology [Fang, Bian, Yang et al. (2018); Yoshimoto, Kaida, Fukao et al. (2013); Yin and Wei (2018)].

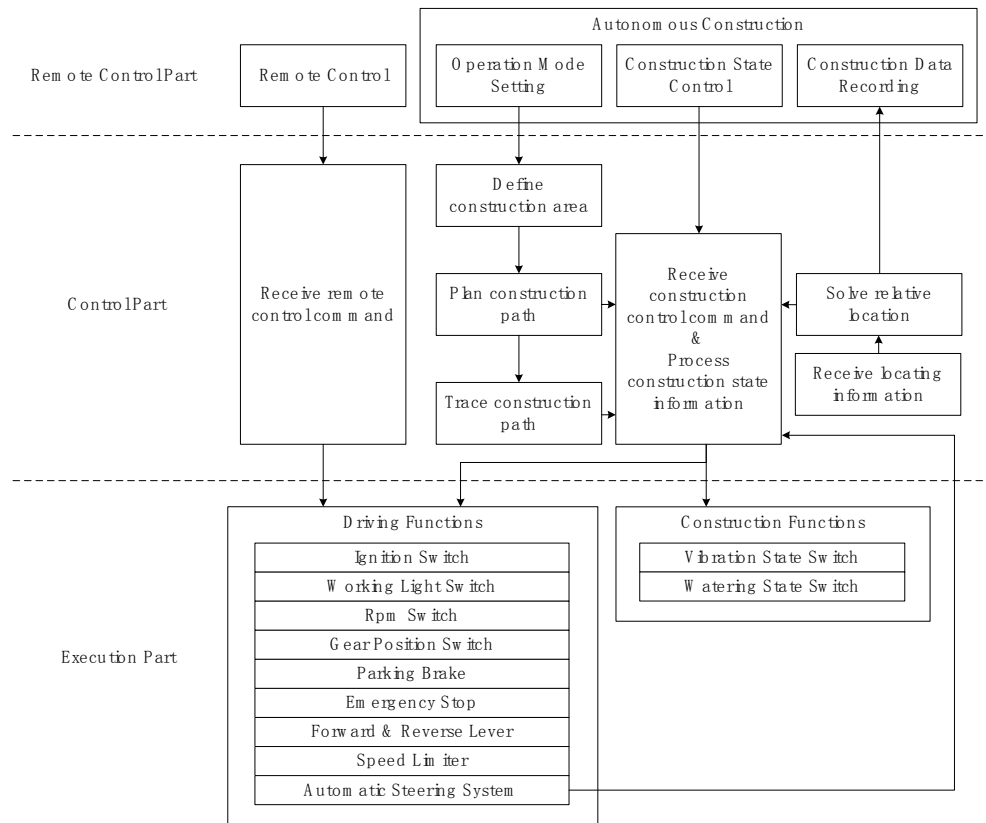

Figure 8: The block diagram of the software layer control

As the remote control command is transmitted from top to bottom, the control part controls the execution part using a specific strategy. The PLC realizes the autonomous construction by controlling the automatic steering system, working light switch, rpm switch, gear position switch, parking brake, emergency stop, vibration state switch, watering state switch, forward & reverse lever, and speed limiter. The automatic steering system controls the steering angle of the roller body by driving the steering wheel motor according to the control command sent by the PLC. The PLC previews the construction path during the autonomous construction process, solves the steering angle deviation with

the relative locating information, and tracks the construction path through PID control [Lu, Chen, Shen et al. (2007); Wit, Crane and Armstrong (2004)].

The rpm switch, gear position switch, and the speed limiter jointly manage the speed of the roller by adjusting the switch and the potentiometer. Therefore, in the process of autonomous construction, the construction speed can be adjusted according to the construction technology to meet the construction demand. Meanwhile, the vibration state switch and the watering state switch respectively control the vibration and watering function of the roller by driving the vibration compacting device of the roller and the water tank. During the autonomous construction process, it will start and stop autonomously according to construction technology. Moreover, the forward & reverse lever controls the driving direction of the roller by adjusting the potentiometer, and the driving direction automatically changes to meet the construction technology during construction.

In the specific process of autonomous construction, the operation mode setting function refers to the PLC using the coordinate transformation method to solve the relative locating information of the satellite. The specific process is as follows:

The latitude, longitude, and heading angle information obtained by the satellite signal receiver is converted to the Cartesian system of the roller vehicle relative to the road surface by the coordinate conversion function under the satellite locating network. Afterward, the PLC defines the construction area based on the constructor's requirement; then, the PLC plans the construction path according to the parameters of the drum width of the vibratory roller, the speed of the construction roller, the repeated compacting distance, and the distance between the path.

Next, the construction state control function means that the constructor can remotely send a control command of the construction state to the PLC through the tablet computer so that it can start the autonomous construction, suspend the autonomous construction, stop the autonomous construction, and even the emergency stop function.

Last but not least, the construction data recording function means that after the autonomous construction starts, the tablet computer will continuously record the relative locating information transmitted from the PLC in real-time and draw it on the construction route map in the tablet, dynamically indicating the change of the position and the actual driving path. The above process also need to record for further analysis.

4 Experiments

4.1 Experimental conditions

According to the previous software and hardware design, the unmanned vibratory roller should be able to perform overall driving and autonomous construction operations under remote control.

In order to verify the effectiveness of the design of the autonomous construction system, it is essential to arrange a specific system experimental scheme, and the remote control operation test and the autonomous construction test was carried out in the construction site using the vibratory roller prototype, and the experimental results were finally analyzed.

The prototype of the vibratory roller used in the experiment was a CC6200 double drum vibratory roller manufactured by Dynapac, as shown in Fig. 9.



Figure 9: Dynapac CC6200 double drum vibratory roller

Because the construction site of the vibratory roller is usually an open space, which has no large buildings and road obstacles around. Moreover, the pavement material compacted by the vibratory roller is asphalt, so there is no slippage. Therefore, a standard flat road surface can simulate the experimental site. The internal battery lead-out line of the vibratory roller supply power for the PLC central controller with 24 V voltage. After manually turning on the external power supply of the vibratory roller, the remote control can operate through the tablet. In the state where the wireless configuration is confirmed to connect on the tablet, the experimental test can start after the ignition switch first set on. In this way, the experimental remote commands include remote driving control and three autonomous construction operations.

By observing whether the lower computer receives the command from the upper computer, whether the operation performance is correct can judge the validity of the autonomous construction control system. At this time, the experimental result records the actual operation of the roller.

4.2 Experimental result

The experimental conditions described in the previous section are all designed under the construction technology of the roller. The communication interaction between the upper computer and the lower computer can verify The effectiveness of the autonomous construction system.

In particular, the driving operation of the vibratory roller has the feature of step-by-step operation; for example, in the driving mode, it is required to maintain the driving state at the time of steering. Therefore, it is also possible to test whether the autonomous construction system has a control signal conflict during operations.

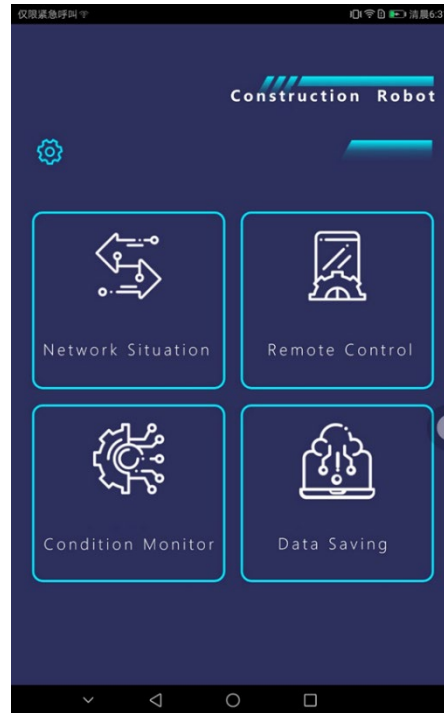

Figure 10: The main screen on the Android-based tablet computer

The main screen and remote control interface of driving functions on the Android-based tablet computer are shown in Figs. 10 and 11. Through a series of experimental tests, the unmanned vibratory roller can complete the specific driving operations of the remote control correctly and quickly, which is in line with the remote operation effectiveness requirements of the autonomous construction system.

Following this, the autonomous construction interface on the Android-based tablet computer is shown in Fig. 12. According to the experimental test, the unmanned vibratory roller can complete the autonomous construction with construction technology. The series of results shown in Fig. 13 can obtain from recalling the data recorded in the tablet computer and analyzing it by Matlab.

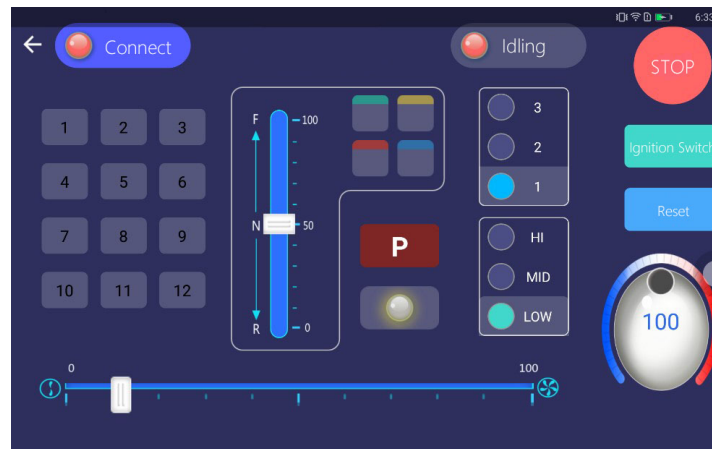

Figure 11: The remote control interface on the tablet



Figure 12: The autonomous construction interface on the tablet

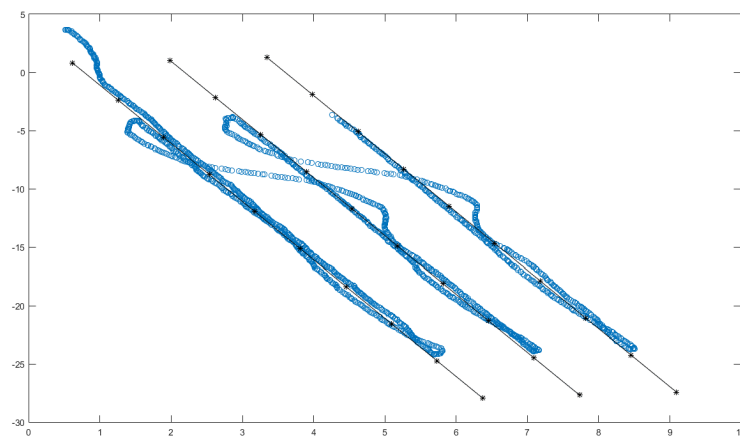

Figure 13: The recorded data of autonomous construction

Fig. 13 shows a map of a construction area used in a field experiment, which is in a Cartesian coordinate axis in meters. The blue dot matrix is the position of the roller in a series of continuous time, and the black line with points is the path planned by the PLC central controller. By analyzing the recorded data, it can observe that the autonomous construction system can drive the roller tracing path for autonomous construction and complete the compaction of a construction area.

5 Conclusion

This paper analyzes and summarizes the requirements of the vibratory roller in road engineering, and simultaneously develops and implements the autonomous construction system of the unmanned vibratory roller. A specific type of vibratory roller sets as a test vehicle for system experiments.

The design of the entire autonomous construction system is in the form of a combination of software and hardware. The hardware part takes PLC as the central controller, and the components include various I/O, relay devices, and wireless devices. The software part is designed based on specific construction technology requirements, with transparent process and modularity. In the end, the unmanned vibratory roller can perform driving operations and autonomous construction under remote control.

Meanwhile, the autonomous construction system designed in this paper also has some parts that need further research, such as the precision of construction. More complex path tracing and control algorithms may solve various problems on the construction site and improve the accuracy of the system. In terms of safety design, combined with machine vision, the surrounding environment of the roller and the position of the constructor can be adequately judged, thereby ensuring the safety of the driving and construction.

Funding Statement: This work was supported by the Natural Science Foundation of Jiangsu Province (BK20170681, BK20180701), and the National Natural Science Foundation of China (51675281).

Conflicts of Interest: The authors declare that they have no conflicts of interest to report regarding the present study.

References

- Ali, M.; Bagchi, S.** (2018): Hybrid architecture for autonomous load balancing in distributed systems based on smooth fuzzy function. *Intelligent Automation and Soft Computing*, vol. 24, no. 4, pp. 851-868.
- Anderson, S. J.; Karumanchi, S. B.; Iagnemma, K.** (2012): Constraint-based planning and control for safe, semi-autonomous operation of vehicles. *IEEE Intelligent Vehicles Symposium*, pp. 383-388.
- Chayama, K.; Fujioka, A.; Kawashima, K.; Yamamoto, H.; Nitta, Y. et al.** (2014): Technology of unmanned construction system in Japan. *Journal of Robotics and Mechatronics*, vol. 26, no. 4, pp. 403-417.
- Fang, X.; Bian, Y.; Yang, M.; Liu, G.** (2018): Development of a path following control

model for an unmanned vibratory roller in vibration compaction. *Advances in Mechanical Engineering*, vol. 10, no. 5, pp. 1-16.

Fu, J.; Jenelius, E.; Koutsopoulos, H. N. (2017): Identification of workstations in earthwork operations from vehicle GPS data. *Automation in Construction*, vol. 83, pp. 237-246.

Kayacan, E.; Saeys, W.; Ramon, H.; Belta, C.; Peschel, J. M. (2018): Experimental validation of linear and nonlinear MPC on an articulated unmanned ground vehicle. *IEEE/ASME Transactions on Mechatronics*, vol. 23, no. 5, pp. 2023-2030.

Kitahara, S.; Takashi, Y. (2006): Deployment of construction robots applying the information technology and network system. *Automation and Robotics in Construction*, pp. 19-23.

Kuenzel, R.; Teizer, J.; Mueller, M.; Blickle, A. (2016): SmartSite: intelligent and autonomous environments, machinery, and processes to realize smart road construction projects. *Automation in Construction*, vol. 71, pp. 21-33.

Lu, M.; Chen, W.; Shen, X.; Lam, H. C.; Liu, J. (2007): Positioning and tracking construction vehicles in highly dense urban areas and building construction sites. *Automation in Construction*, vol. 16, no. 5, pp. 647-656.

Schmidt-Didlaukies, H. M.; Sørensen, A. J.; Pettersen, K. Y. (2018): Modeling of articulated underwater robots for simulation and control. *IEEE/OES Autonomous Underwater Vehicle Workshop*, pp. 1-7.

Suzuki, T.; Kitamura, M.; Amano, Y.; Hashizume, T. (2011): High-accuracy GPS and GLONASS positioning by multipath mitigation using omnidirectional infrared camera. *IEEE International Conference on Robotics and Automation*, pp. 311-316.

Tan, S.; Zhao, X.; Yang, J.; Zhang, W. (2017): A path tracking algorithm for articulated vehicle: development and simulations. *IEEE Transportation Electrification Conference and Expo, Asia-Pacific*, pp. 1-6.

Vahedifard, F.; Nili, M.; Meehan, C. L. (2010): Assessing the effects of supplementary cementitious materials on the performance of low-cement roller compacted concrete pavement. *Construction and Building Materials*, vol. 24, no. 12, pp. 2528-2535.

Weng, L.; Song, D. Y. (2005): Path planning and path tracking control of unmanned ground vehicles. *37th Southeastern Symposium on System Theory*, pp. 262-266.

Werfel, J.; Petersen, K.; Nagpal, R. (2014): Designing collective behavior in a termite-inspired robot construction team. *Science*, vol. 343, no. 6172, pp. 754-758.

Wit, J.; Crane III, C. D.; Armstrong, D. (2004): Autonomous ground vehicle path tracking. *Journal of Robotic Systems*, vol. 21, no. 8, pp. 439-449.

Yao, D.; Xie, H.; Qiang, W.; Liu, Y.; Xiong, S. (2018): Accurate trajectory tracking with disturbance-resistant and heading estimation method for self-driving vibratory roller. *IFAC-PapersOnLine*, vol. 51, no. 31, pp. 754-758.

Yao, Y. S.; Feng, Z. X.; Zhu, W. M.; Yao, L. N. (2007). Noise analysis of vibratory roller. *Road Machinery & Construction Mechanization*, vol. 24, no. 7, pp. 47-49.

Yin, B.; Wei, X. (2018): Communication-efficient data aggregation tree construction for

complex queries in IoT applications. *IEEE Internet of Things Journal*, vol. 6, no. 2, pp. 3352-3363.

Yoshimoto, T.; Kaida, K.; Fukao, T.; Ishiyama, K.; Kamiya, T. et al. (2013): Backward path following control of an articulated vehicle. *Proceedings of the IEEE/SICE International Symposium on System Integration*, pp. 48-53.

Zhang, Z. F.; Feng, Z. X.; Liu, B. X. (2007). Vibration effects of vibratory roller on nearby buildings and its control measures. *Journal of Chang'an University (Natural Science Edition)*, vol. 1, no. 117.

Zhu, Q. D.; Yang, Z. B. (2019): Intelligent power compensation system based on adaptive sliding mode control using soft computing and automation. *Computer Systems Science and Engineering*, vol. 34, no. 4, pp. 179-189.