

EFFECT OF ABSORBER TYPES OF CONVENTIONAL DISTILLERS ON THE AMOUNT OF DISTILLED WATER PRODUCTION

M. Mirmanto*, M. Wirawan, I.M.A. Sayoga, S. Syahrul, M. Faisal, A. Abdullah

Mechanical Engineering Department, Engineering Faculty, Mataram University, Jl. Majapahit no. 62, Mataram, NTB, 83125, Indonesia.

ABSTRACT

Due to clean water crisis in the dry season in some places in Indonesia, experiments to find the best distiller to provide distilled water were performed. The long-term goal of this study is to create a distiller that is cheap, simple, easy to make, durable, low maintenance, but produces plenty of distilled water. Three identical conventional distillers with different absorbers had been tested for about 6 days in May 2019. These three distillers were used to evaporate and condense seawater to be distilled water. The absorbers types employed were type A, B, and C. The results show that the distiller with the type C absorber is the best distiller. The distilled water produced is 1.3 liter per day. Therefore, this distiller is recommended to use, develop and study further.

Keywords: *distiller, distilled water, absorber*

1. INTRODUCTION

Clean water, in dry areas or the coastal areas is very difficult to obtain. In several regions in Indonesia, the crisis of clean water is also experienced when the dry season arrives, such as in NTT, Central Lombok, Gunung Kidul, Yogyakarta, East Java and other areas in Indonesia. Meanwhile, clean water needs are a basic human need. Clean water can actually be produced in various ways such as by purifying dirty water or waste, distillation of sea, e.g. Mirmanto (2003), Mukaddin et al. (2013), reverse osmosis, Khanzada et al. (2017) and so on. However, those methods are still not productive because they yield less clean water, except for the RO method. The RO method is very effective, high productivity, but it needs high costs because it requires large electrical energy, Slocum et al. (2016). Therefore, making clean water with an RO method is only beneficial for large industries or community groups, but it is not suitable for every household. The cheapest way is to use solar water distillation, Mirmanto (2003), Mukaddin et al. (2013), and Gugulothu et al. (2015). The distillation of seawater with solar power has many models, namely prism model, pyramid model, and centralized collector model, Manchanda and Kumar (2017). Those models are classified as conventional distillation. The main problem with conventional solar distillation is low productivity, therefore, more comprehensive and in-depth researches need to be conducted. Several models have been made with attention on increasing the productivity of distilled water. In addition, the model or shape of distillers can be distinguished technically such as evaporation-condensation, filtration, and crystallization techniques, Alkai et al. (2017).

Currently, several desalination technologies have been developed. However, these technologies are still in development, e.g. greenhouse, natural vacuum, solar chimney, membrane distillation (MD), adsorption desalination, forward osmosis (FO), membrane bioreactor (MBR), and ion exchange resin (IXR). The RO with a multistage flashing (MSF) and a multi-effect distillation (MED) system is the most broadly functional desalination. More than 300 million people depend

on water produced by 18426 distillers in 150 countries, which provide more than 86.8 million cubic meters per day as reported by Baawain et al. (2015).

Western and developed countries prefer the RO system because of its high efficiency. However, the Middle East and Gulf countries favour the MSF and MED systems because of the plentiful available grease sources. The major desalination plant that began functioning at the end of 2014 was Ras Al-Khair in Saudi Arabia. This plant produces around 728,000 cubic meters of desalination water per day by employing MSF and RO technology as revealed by Cheong et al. (2016). The second biggest desalination plant is Carlsbad in California, United States, which generates around 190,000 cubic meters of desalination water a day by applying RO equipment, released in December 2015, Heck et al. (2016). The simplest, easiest to make, and easy to operate desalination equipment is a solar still distillation (SSD) system. SSDs are very suitable for remote and rural areas in Indonesia to cope with the crisis period of clean water in the dry season. SSD production is low but it does not require electrical energy. This tool is quite solar-powered, as ever be performed by Mirmanto (2003), Mukaddin et al. (2013), Jumineti (2014), and Heck et al. (2016). Therefore, this research focuses on increasing distilled water productivity from SSD distillers.

The problem with SSDs is that their water production capacity is very low because their productivity depends on area and environmental conditions. The production of distilled water is only 0.5 liters per day, Mirmanto (2003). A distiller with pyramid-shaped sizing of 1 m x 1 m and a total height of about 50 cm yields only 15 ml/h. For this reason, the SSD should be modified. Three types of absorber models are proposed to be investigated in this study with the main aim of knowing their performances. Therefore, from this study, one best distiller will be attained. Further research that may be performed is to develop this best distiller. The long-term goal of this study is to create a distiller that is cheap, simple, easy to make, durable, low maintenance, but produces plenty of distilled water. Moreover, the distiller must be able to meet the water needs of people living near the beaches or in coastal areas. In the dry season, this distiller is also expected to provide clean water from dirty water in the dry villages.

*Corresponding Author Email: m.mirmanto@unram.ac.id

2. RESEARCH METHOD

2.1 Experimental Facility and Method

The schematic diagram of the experimental facility is shown in Fig.1, while the dimension of the distiller is given in Fig.2. This research was performed experimentally using a test rig consisting of three distillers, seawater reservoir, buoy and distilled water storage/ bottle, anemometer, thermocouple and pyranometer. All temperatures were read directly on the computer using the data logger National Instrument, NI9417 interfaced with LabView, and were measured using calibrated K-type thermocouple. Seawater was put in the upper tank/ reservoir until the box was full. Then the valve installed at the pipeline was open,

so that the seawater flowed toward the level control box. In the level control box, the height of the seawater level was persistent due to the floating ball. From the level control box, water flowed towards the distiller box. The water level in the distiller was the same as the water level in the control level box. In the distiller box, the seawater evaporated. After the seawater turned into vapour, then the vapour leaved the surface of the remaining seawater and went to the cover glass. On the glass, the vapour condensed because the glass temperature was lower than the absorber temperature or the vapour temperature. The formed dew flowed down the glass surface towards the distiller tip. At the end of the distiller, the dew collected and finally flowed out towards the available bottle. The absorber types examined were flat galvalum absorber (type A), flat galvalum with iron fibers (type B), and flat

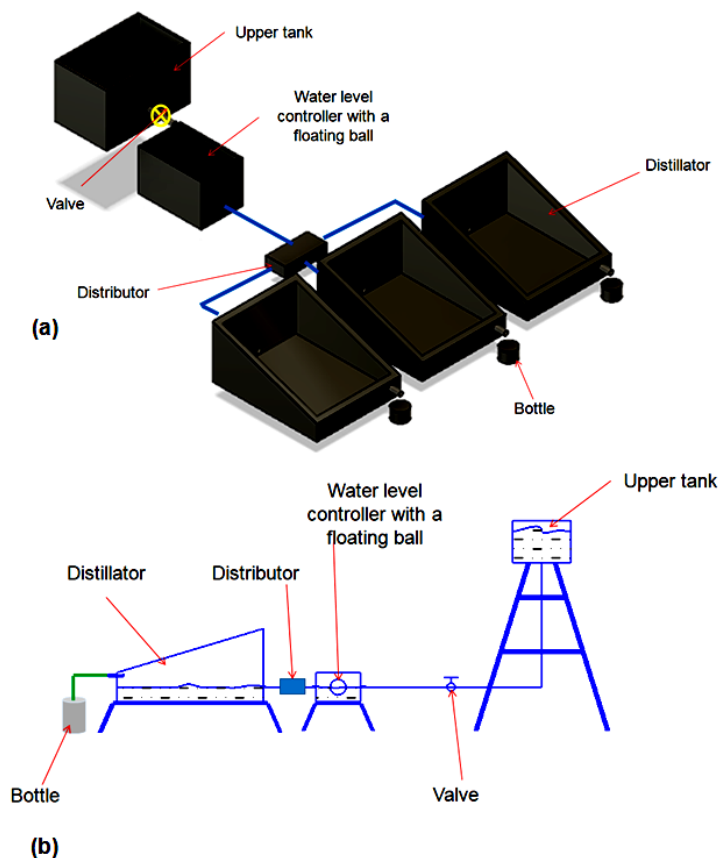

Fig. 1 Schematic diagram of the research apparatus; (a) three dimensional view, (b) two dimensional view.

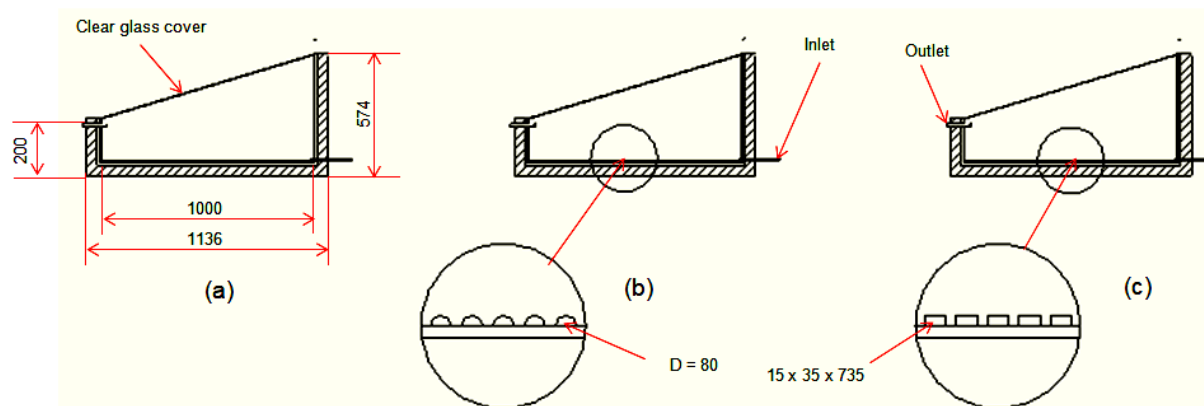

Fig. 2 Construction of the distillers with absorber types; (a) type A, (b) type B, (c) type C.

galvalum with fins (type C), see Fig. 2. The calibration showed that the uncertainty obtained for the temperatures was $\pm 0.5^\circ\text{C}$. In addition, other parameters attained in this experiment were solar power and environmental wind speed. Solar power was measured using the Lutron SPM-1116SD pyranometer with 5% reading accuracy, and a resolution of 0.1 W/m^2 . Wind speed was measured using the anemometer GM8901 with an accuracy of $\pm 3\%$ reading and a resolution of 0.1 m/s .

The distilled water production was balanced at every 30 minutes until the experiment finished. The experiment started at 09.00 MIT (Middle Indonesia Time) and finished at 16.00 MIT. The solar power and the wind velocity were also recorded every 30 minutes. The experiments had been performed for 6 days. The accumulation of distilled water can be known using equation (1), which is a general equation that can be obtained in several textbooks such as Physics books and it is written as:

$$m = \sum_0^t (m_{(t)} - m_b) \quad (1)$$

m is the mass (kg), t is time (s), m_b is the empty bottle mass (kg).

2.2 Heat Transfer Analysis

To determine the energy absorbed by the seawater inside the distilled box, equation (2) can be utilized. This equation can be found in Holaman (2002).

$$E_s = m_s c_p (T_f - T_i) \quad (2)$$

E_s is the sensible energy (J), m_s is the mass of the seawater inside the distiller (kg), c_p is the specific heat of seawater (J/kgK), T_i and T_f are the initial and final seawater temperatures ($^\circ\text{C}$). The seawater then vaporizes at the atmospheric pressure. The energy required for evaporating the seawater can be estimated using equation (3), which can be obtained in Holman (2002).

$$E_l = m_e h_{fg} \quad (3)$$

E_l is the evaporation energy (J), m_e is the evaporated seawater mass (kg), while h_{fg} is the enthalpy for evaporation (J/kg). The energy absorbed by the water and the absorber, which is called as energy input, is calculated using equation (4), which can be found in Duffie and Beckman (2013), and in Mirmanto (2003).

$$E_{in} = \tau A I_T t \quad (4)$$

τ is the transitivity of the clear glass cover, which is of approximately 0.88, see Idi and De (2011), Syahri (2011), A is the aperture area (m^2), I_T is the solar power (W/m^2), which is measured directly in this study. Then the energy losses, E_{loss} is determined using energy balance equation that can be attained in Holman (2002).

$$E_{loss} = E_{in} - E_s - E_l \quad (5)$$

To find the heat transfer rate for this study, the energy is divided by the time t , so that the unit is in watt. The heat loss also can be determined using equations (5) divided by time. The temperatures of the outer walls of the distiller are higher than the ambient temperature; therefore, there is heat loss from the author walls to the environment that can be estimated using equations that can be found in Holman (2002), Mulyanef (2014).

$$Q_c = h A_w (T_w - T_\infty) \quad (6)$$

$$Q_r = A_w \sigma (T_w^4 - T_\infty^4) \quad (7)$$

Q_c is the heat loss due to convection (W), while Q_r is the heat loss due to radiation (W). However, in Equation (7), the temperatures must be in Kelvin.

3. RESULTS AND DISCUSSION

The relationship of energy input (E_{in}) and observation time can be seen in Fig. 3, while relationship of temperatures and time is given in Fig. 4. The energy input can be obtained using equation (4).

Fig. 3 indicates that there is fluctuation of energy input. Fig. 3(a), (b) and (e) are not good because the fluctuation is too big. This fluctuation is due to the cloud. Normally, the maximum energy input occurs at 14.00 MIT as shown by Fig.3(c),(d) and (f), but sometimes suddenly the cloud comes so that the energy input decreases. Even when the sun is fully covered by the cloud, the energy input becomes zero. Now, other variables that had been obtained in the experiments are absorber and water temperatures of three distillers. Fig. 4 shows relationship of absorber temperatures and observation time. The trends of the temperature are almost the same as that of energy input (E_{in}) presented in Fig. 3, however, the absorber temperatures are more persistent. They increase from 09.00 to 14.00 MIT, unless there is cloud. The fluctuations of the absorber temperatures are smooth. This phenomenon was also attained by Mirmanto (2003), Saxena and Deval (2016). For the three types of absorbers indicate almost the same temperatures, however, type C elevates little bit higher than other absorber temperatures. This is due to the prevailing fins that cause larger heat transfer area.

The persistent absorber temperatures are due to the difficulty of the temperatures to change quickly. The solar energy input can easily change but the absorber temperatures take time to change. For example, when the sky is suddenly covered by the cloud, the solar energy input drops quickly and drastically, but the absorber temperature does not change as quickly as the solar energy input. Similarly, from cloudy to clear sky, the solar energy input can increase suddenly, but the absorber temperature does not as quickly as that.

Water temperature inside the distiller was almost the same as the absorber temperature. This was due to the thermal equilibrium between

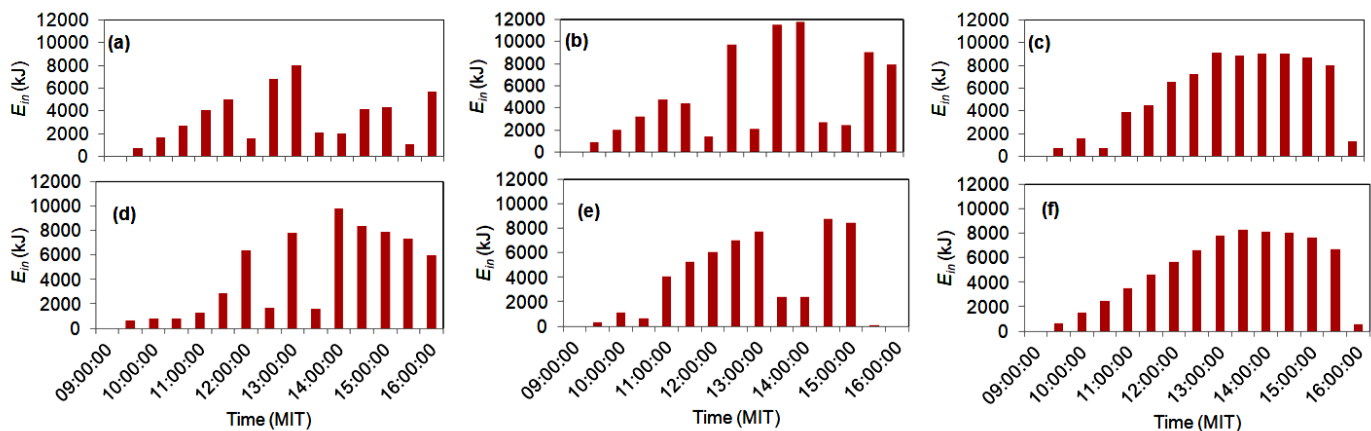

Fig. 3 Relationship of energy input and observation time; (a) day 1, (b) day 2, (c) day 3, (d) day 4, (e) day 5, and (f) day 6 in May 2019 for the three identical distillers.

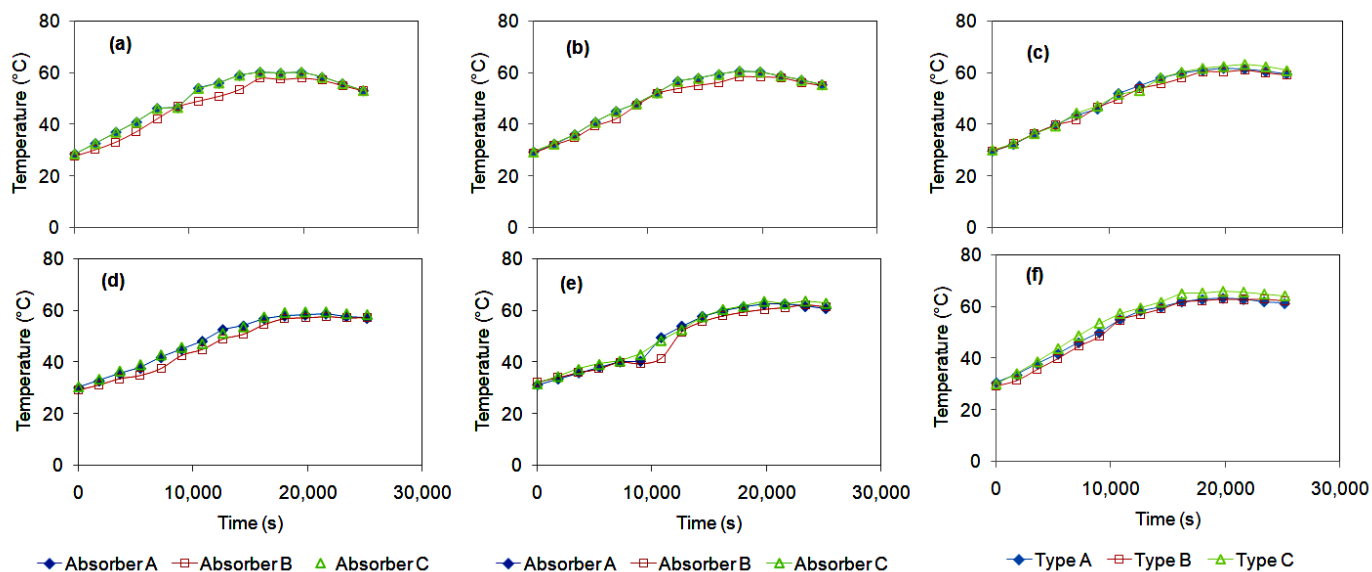

Fig. 4 Relationship of absorber temperatures and time; (a) day 1, (b) day 2, (c) day 3, (d) day 4, (e) day 5, and (f) day 6, in May 2019 for the three identical distillers.

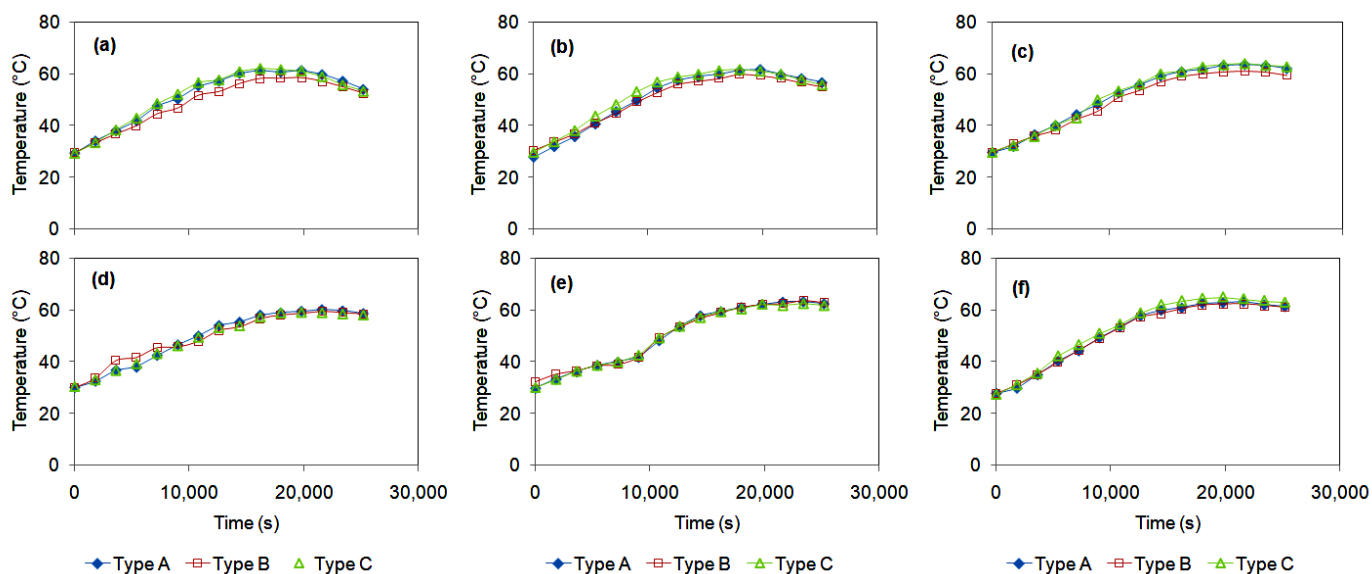

Fig. 5 Relationship of seawater temperatures with time; (a) day 1, (b) day 2, (c) day 3, (d) day 4, (e) day 5, and (f) day 6, in May 2019 for the three identical distillers.

water and absorber as the water and the absorber touched each other. At the day 5, after 13.00 MIT, the solar energy input decreased until before 14.30 MIT. It was enough to influence the absorber and water temperatures to change, see Fig. 4(e) and Fig. 5(e). However, the absorber and water temperatures were not sensitive to the change of solar energy input.

Similarly, the accumulated distilled water was not sensitive to the solar energy input change. It increased although the solar energy input decreased or changed see Fig. 6. However, the distilled water resulted at every hour did not always increase, see Fig. 7. It was different at every hour. Fig. 6 demonstrates the accumulated distilled water production. The last bars at 16.00 MIT indicated the total distilled water production. That was the total amount of distilled water obtained at the day. The trend of the accumulated distilled water with time was almost the same as that of Kabeel (2009). However, the distilled water of Kabeel (2009) was larger than this study. The reason was: this study used a simple triangle distiller, while Kabeel (2009) used a concave

wick distiller. Fig. 6 shows that the distilled water can be harvested after at 11.00 MIT. Nevertheless, distilled water were obtained from distillers with each area of 0.8 m². If the area should be in 1 m², then the distilled water should be divided by 0.8. Therefore, the distilled water production in g/m² was known and presented in Table 1.

Distillers type A and B resulted in more or less the same daily-distilled water, while distiller type C produced more much distilled water. This was due to fins. The fins increased the heat transfer area, so that type C had larger area, consequently, type C produced more much distilled water. There was an additional area due to the iron fibers for type B, however, the iron fibers got rusty so that the heat transfer process was blocked. Therefore, type B could not produce more much distilled water compared to type C, but it resulted in a larger amount of distilled water compared to type A. The areas of type A, B and C were 0.8 m², 1.37 m², and 1.14 m² respectively. Increasing the area of the absorber increased the heat transfer area and temperatures. At the same atmospheric pressure, but different heat transfer area, the produced

vapour was larger, as a result, type B and C produced much distilled water. The distilled water resulted in this study, however, was higher than that of Mirmanto (2003), Mukaddin et al. (2013), and Sathyamurthy et al. (2014). From Fig. 6, type C is the distiller that is recommended for further research.

Fig. 7 exhibits that hourly-distilled water production increases until it has a maximum value then after that it generally decreases smoothly. This due to the increased and decreased solar energy input. Nevertheless, the hourly-distilled water production in this study is lower than that of Kabeel (2009), Mulyanef et al. (2014). Mulyanef et al. (2014) used two incline glass covers, while in this study; the distiller had only one incline glass cover. Fig. 7 shows that the distiller with type C absorber can produce larger amount of hourly-distilled water production.

Another parameter that designates the distiller performance is efficiency. The efficiency is calculated using equation (8) that can be obtained in Holman (2002), and stated as:

$$\eta = \frac{E_u}{E_{in}} = \frac{E_s + E_l}{E_{in}} \quad (8)$$

E_u is the total useful energy (J), however, equation (8) is the instantaneous efficiency. The efficiency attained in this study is given in Fig. 8. Fig. 8 shows that instantaneous efficiency increases with time. This is due to the increased total useful energy with time. It even gets a maximum efficiency of about 100%. This can only happens when the solar energy input drops suddenly. The distiller is still hot, so that the useful energy remains there, and the instantaneous distilled water still comes out. Even at this condition, the instantaneous efficiency can be more than 100%.

Table 1 Distilled water production of three identical distillers with different absorber types

Daily distilled water production (g/m ²)			
	Type A	Type B	Type C
Day 1	1158.8	1127.5	1363.8
Day 2	1142.5	1210.0	1321.3
Day 3	1138.8	1181.3	1252.5
Day 4	926.3	933.8	1047.5
Day 5	912.5	915.0	1015.0
Day 6	1066.3	1153.8	1551.3

It must be remembered that the efficiency in Fig. 8 is due to accumulation useful energy, because the usefull energy is estimated using accumulation distilled water. Therefore, a common efficiency of distiller should be presented. This efficiency is shown in Fig. 9. Nevertheless, this instantaneous efficiency describes that the distiller using type C absorber has a higher efficiency. Then from the efficiency viewpoint, type C is the best.

Fig. 9 presents everage daily efficiencies. Those are efficiencies calculated on the average useful heat bases. The average useful heat can be estimated using equation (9) that can be attained in Holman (2002) and written as:

$$Q_u = \frac{E_u}{t} \quad (9)$$

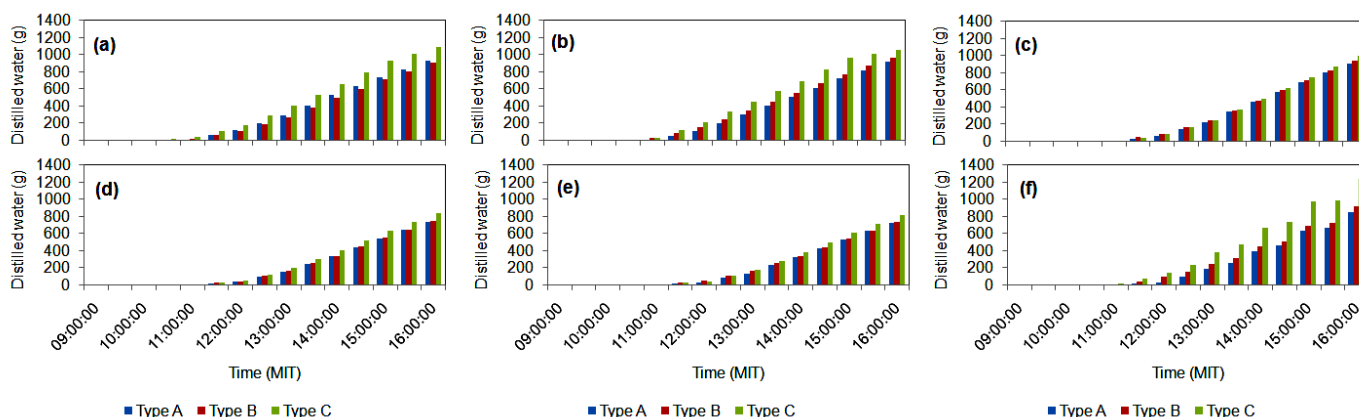

Fig. 6 Relationship of accumulated distilled water and observation time; (a) day 1, (b) day 2, (c) day 3, (d) day 4, (e) day 5, and (f) day 6 in May 2019 for the three identical distillers.

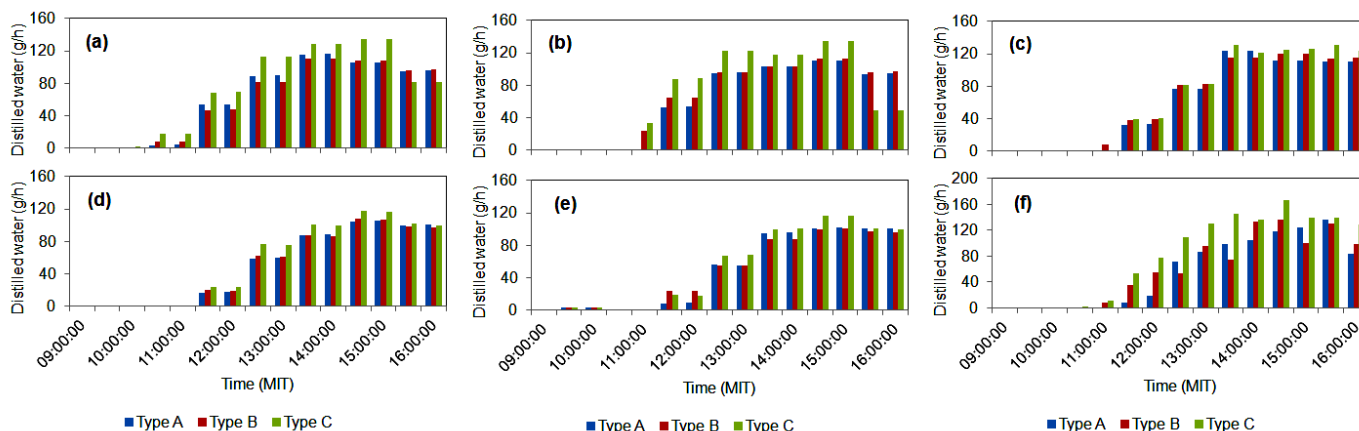

Fig. 7 Relationship of hourly distilled water and observation time; (a) day 1, (b) day 2, (c) day 3, (d) day 4, (e) day 5, and (f) day 6 in May 2019 for the three identical distillers.

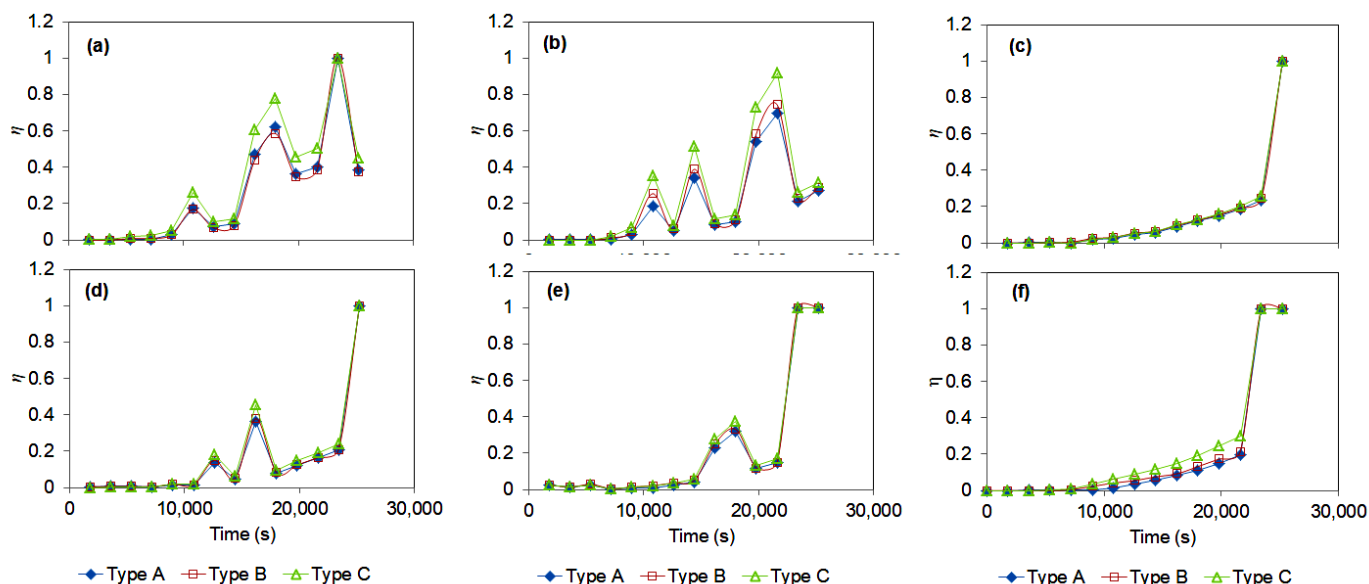

Fig. 8 Instantaneous efficiency versus time collected for 6 days

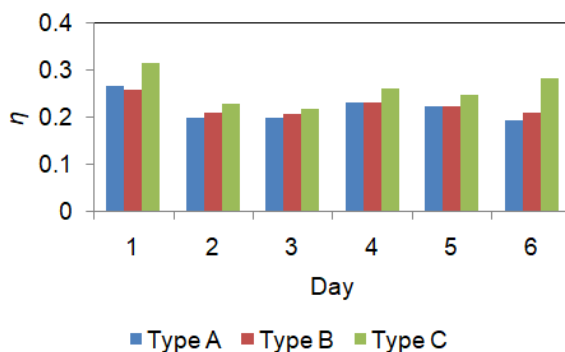

Fig. 9 Average daily efficiency

$$Q_u = \frac{E_{in}}{t} \quad (10)$$

Q_u is the useful heat transfer rate (W), and Q_{in} is the heat input (W). The average daily efficiency, η_{av} , is computed using equation (11) that can be found in Heat Transfer books such as Holman (2002), Incropera et al. (2006).

$$\eta_{av} = \frac{Q_u}{Q_{in}} \quad (11)$$

4. CONCLUSION

Experimental study to assess the performances of three identical distillers with different absorber types has been performed. The types of absorbers tested were type A, B, and C. The absorber that has fins exhibits the best performance. It produces larger amount of distilled water compared to other absorber types. Type C is recommended to develop and study to increase its efficiency.

ACKNOWLEDGEMENTS

The authors would like to acknowledge the DRPM for the funding through research PD schema with the contract number 182/SP2H/LT/DRPM/2019.

NOMENCLATURE

A	cross-sectional area (m ²)
c_p	specific heat (J/kg K)
E_{in}	Solar energy input(J)
E_l	latent energy (J)
E_s	sensible energy (J)
E_{loss}	losses energy (J)
h_{fg}	enthalpy of evaporation (J/kg)
m	mass (kg)
m_b	mass of bottle (kg)
m_e	mass of evaporation (kg)
m_s	mass of seawater (kg)
m_t	mass at the time t (kg)
Q_c	convection heat loss(W)
Q_r	radiation heat loss (W)
Q_u	useful heat (W)
Q_{in}	heat input (W)
t	time (s)
T_f	final seawater temperature (°C)
T_i	initial seawater temperature (°C)
T_w	wall temperature (°C)
T_{∞}	ambient temperature (°C)
η	instantaneous efficiency
η_{av}	average efficiency

REFERENCES

- Alkaisu, A., Mossad, R., Sharifian-Barforoush, A., 2017, "A Review of the Water Desalination Systems Integrated with Renewable Energy", *Energy Procedia*, **110**, 268 – 274.
<https://doi.org/10.1016/j.egypro.2017.03.138>
- Baawain, M., Choudri, B.S., Ahmed, M., Purnama, A., 2015, *Recent Progress in Desalination, Environmental and Marine Outfall Systems*, Springer.
https://doi.org/10.1007/978-3-319-19123-2_1
- Cheong, S.M., Choi, G.W., Lee, H.S., 2016, "Barriers and Solutions to Smart Water Grid Development", *Environmental management*, **57**(3), 509-615.
<https://doi.org/10.1007/s00267-015-0637-3>
- Duffie, J.A., Beckman, W.A., 2013, *Solar Engineering of Thermal Processes*, 4th Edition y John Wiley & Sons, Inc., Hoboken, New Jersey.
- Gugulothu, R., Somanchi, N.S., Reddy, K.V.K., Gantha, D., 2015, "A Review on Solar Water Distillation Using Sensible and Latent Heat", *Procedia Earth and Planetary Science*, **11**, 354 – 360.
<https://doi.org/10.1016/j.proeps.2015.06.072>
- Holman, J.P., 2002, *Heat Transfer*, McGraw-Hill Education (India) Pvt Limited.
- Heck, N., Paytan, A., Potts, D.C., Haddad, B., 2016, "Coastal residents' literacy about seawater desalination and its impacts on marine ecosystems in California", *Marine Policy*, **68**, 178-86.
<https://doi.org/10.1016/j.marpol.2016.03.004>
- Idi, B.Y., De, D.K., 2011, "Transmissivity of the Glazing Surface of a Solar Flat Plate Collector Based on the Metrological Parameters of Yola, Nigeria", *Journal of American Science*, **7**(1), 639-643.
- Incropera, F., DeWitt, D.P., Bergman, T.L. Lavine, A.S., 2006, *Fundamentals of Heat and Mass Transfer*, 6th Edition, John Wiley & Sons, Hoboken.
- Jumineti, D., 2014, *Analisa Kinerja Alat Destilasi Penghasil Air Tawar Dengan Sistem Evaporasi Uap Tenaga Surya*, Skripsi, Jurusan Teknik Perkapalan, ITS, Surabaya, Indonesia.
- Kabeel, A.A., 2009, "Performance of Solar Still with a Concave Wick Evaporation Surface", *Energy*, **34**, 1504–1509.
<http://dx.doi.org/10.1016/j.energy.2009.06.050>
- Khanzada, N.K., Khan, S.J., Davies, P.A., 2017, "Performance Evaluation of Reverse Osmosis (RO) Pre-Treatment Technologies for In-Land Brackish Water Treatment", *Desalination*, **406**, 44-50.
<http://dx.doi.org/10.1016/j.desal.2016.06.030>
- Manchanda, H., Kumar, M., 2017, "Study of Water Desalination Techniques and a Review on Active Solar Distillation Methods", *Environmental Progress & Sustainable Energy*, **37**(1), 444-464.
<http://dx.doi.org/10.1002/ep.12657>
- Mirmanto, 2003, *Distilasi Surya Pengubah Air Laut Menjadi Air Tawar*, Laporan penelitian DPP-SPP, Universitas Mataram, Indonesia.
- Mukaddim, A., Wirawan, M., Alit, I.B., 2013, "Analisa Pengaruh Variasi Bentuk Absorber pada Alat Destilasi Air Laut Terhadap Kenaikan Suhu Air dalam Ruang Pemanas dan Jumlah Penguapan Air yang Dihasilkan", *Dinamika Teknik Mesin*, **3**(2), 127-135.
- Mulyanef, Marsal, Arman, R., Sopian, K., 2014, *Sistem Distilasi Air Laut Tenaga Surya Menggunakan Kolektor Plat Datar dengan Tipe Kaca Penutup Miring*, Teknik Mesin, Universitas Bung Hatta, Padang, Indonesia.
- Sathyamurthy, R., Nagarajan, P.K., Kennady, H.J., Ravikumar, T.S., Paulson, V., Ahsan, A., 2014, "Enhancement of Fresh Water Production of Triangular Pyramid Solar Still Using Phase Change Material as Storage Material", *Frontiers in Heat and Mass Transfer*, **5**(3), 1-5.
<http://dx.doi.org/10.5098/hmt.5.3>
- Saxena, A., Deval, N., 2016, "A High Rated Solar Water Distillation Unit for Solar Homes", *Journal of Engineering*, **2016**, 1-8.
<http://dx.doi.org/10.1155/2016/7937696>
- Slocum, A.H., Haji, M.N., Trimble, A.Z., Ferrara, M., Ghaemsaïdi, S.J., 2016, "Integrated Pump Hydro Reverse Osmosis System", *Sustainable Energy Technologies and Assessments*, **18**, 80-89.
<http://dx.doi.org/10.1016/j.seta.2016.09.003>
- Syahri, M., 2011, "Rancang Bangun Sistem Desalinasi Energi Surya Menggunakan Absorber Bentuk Sepatu Elip Melintang", *Prosiding Seminar Nasional Teknik Kimia "Kejuangan"*, Pengembangan Teknologi Kimia untuk Pengolahan Sumber Daya Alam Indonesia, Yogyakarta, 22 Februari.